

16m Dome

Data Sheet

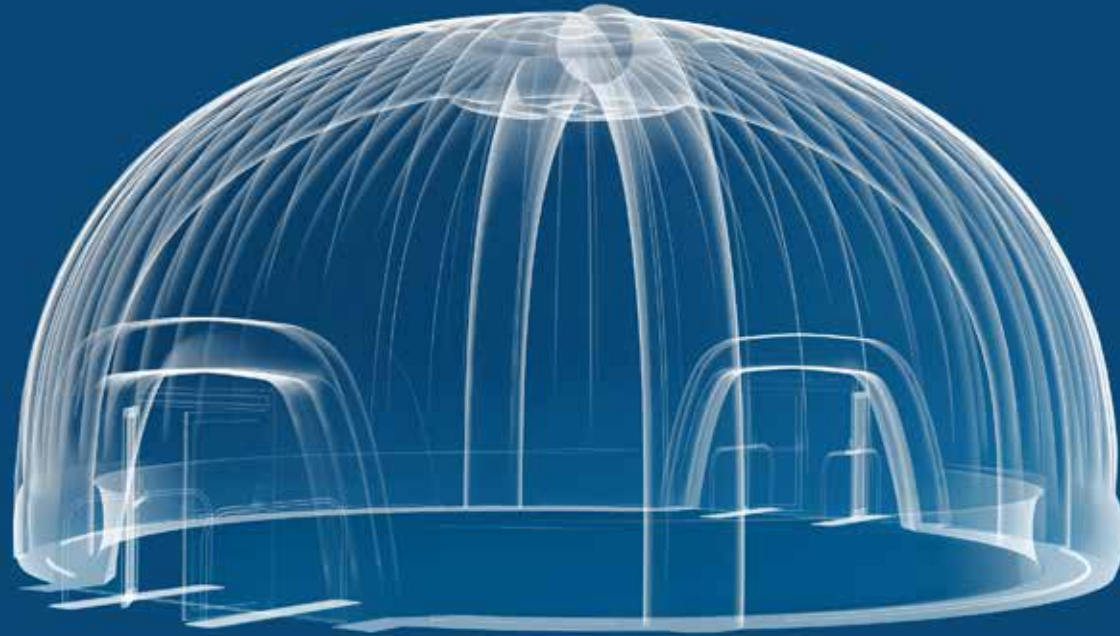

Product Variations

M3 Air is a brand new range of high performance, beautifully designed, and practical temporary event structures.

Traditionally inflatable structures have been light weight and open to abuse from weather and more importantly the wind. The new M3 Air range offers greatly improved performance through extensive design and engineering. M3 Air inflatable event structures can withstand wind speeds and gusts of up to 55mph therefore ensuring your event is not effected at anytime of the year. Creatively designed, the M3 Air products are the worldwide leader in inflatable structures. **The M3 Air Dome range includes:**

M3 Air Dome Air-Beam collection

The highest rated inflatable temporary dome on the market can be used in winds up to 55mph. This is because of the regulated pressurised air beams which provide a solid support skeleton to the overall structure. An M3 Air dome offers a contemporary look and market leading performance.

M3 Air Dome standard collection

The Standard M3 Air Dome range offers the same high class finish and look, and are the same product in every way, apart from the Air beams. This efficient, professionally made unit offers a superb solution to any event.

The M3 Air range of structures can be tailored to suit your event needs, we offer branding with options including direct print and replaceable printed covers. The M3 Air range also offers great flexibility as all the products can be seamlessly joined together, providing wonderful multi room environments. We also offer a range of connecting tunnels to add a sleek finish to the event structures.



General Arrangement

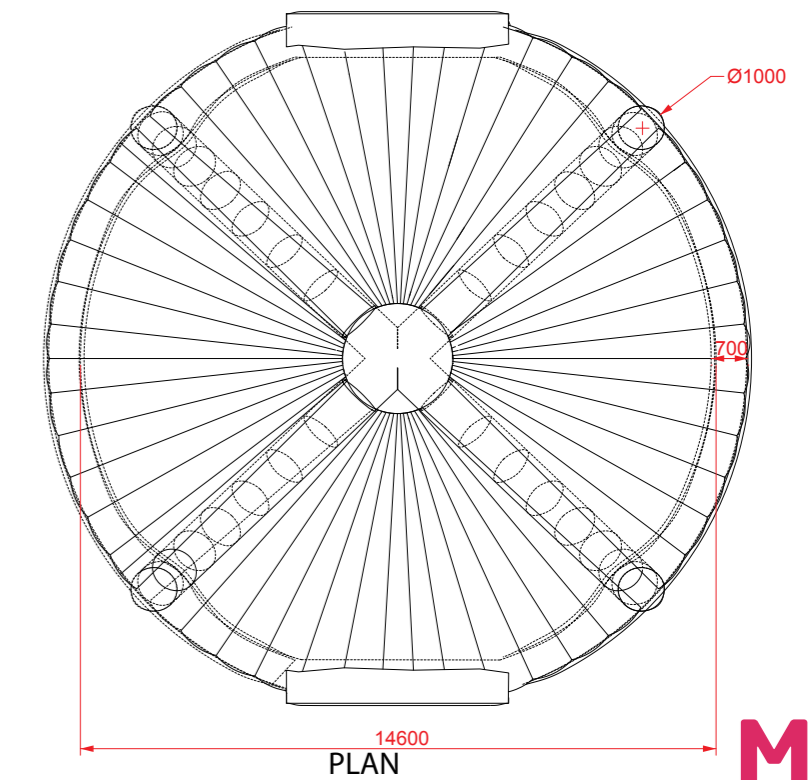
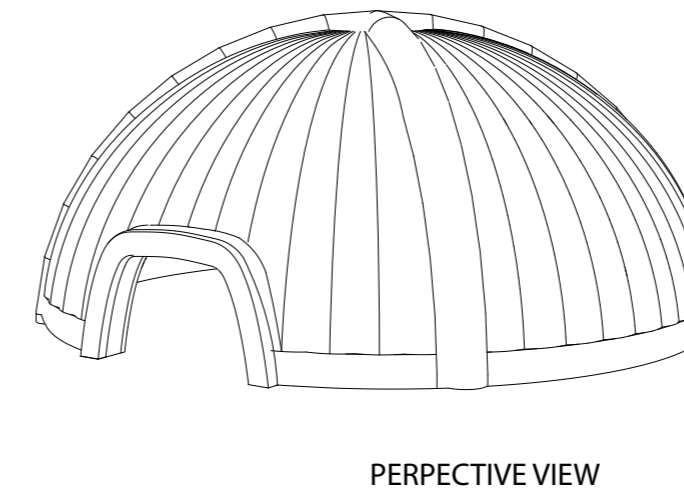
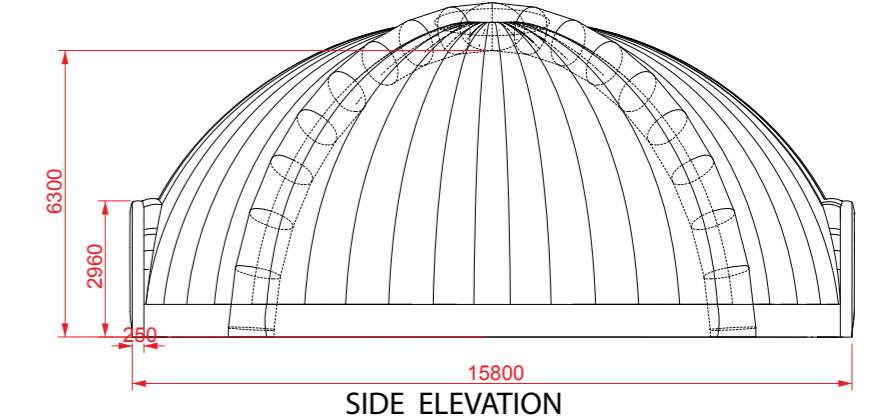
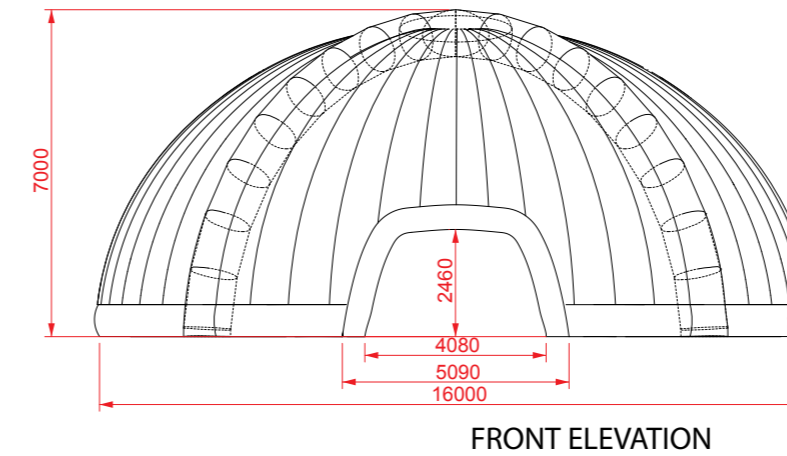

Product Accessories

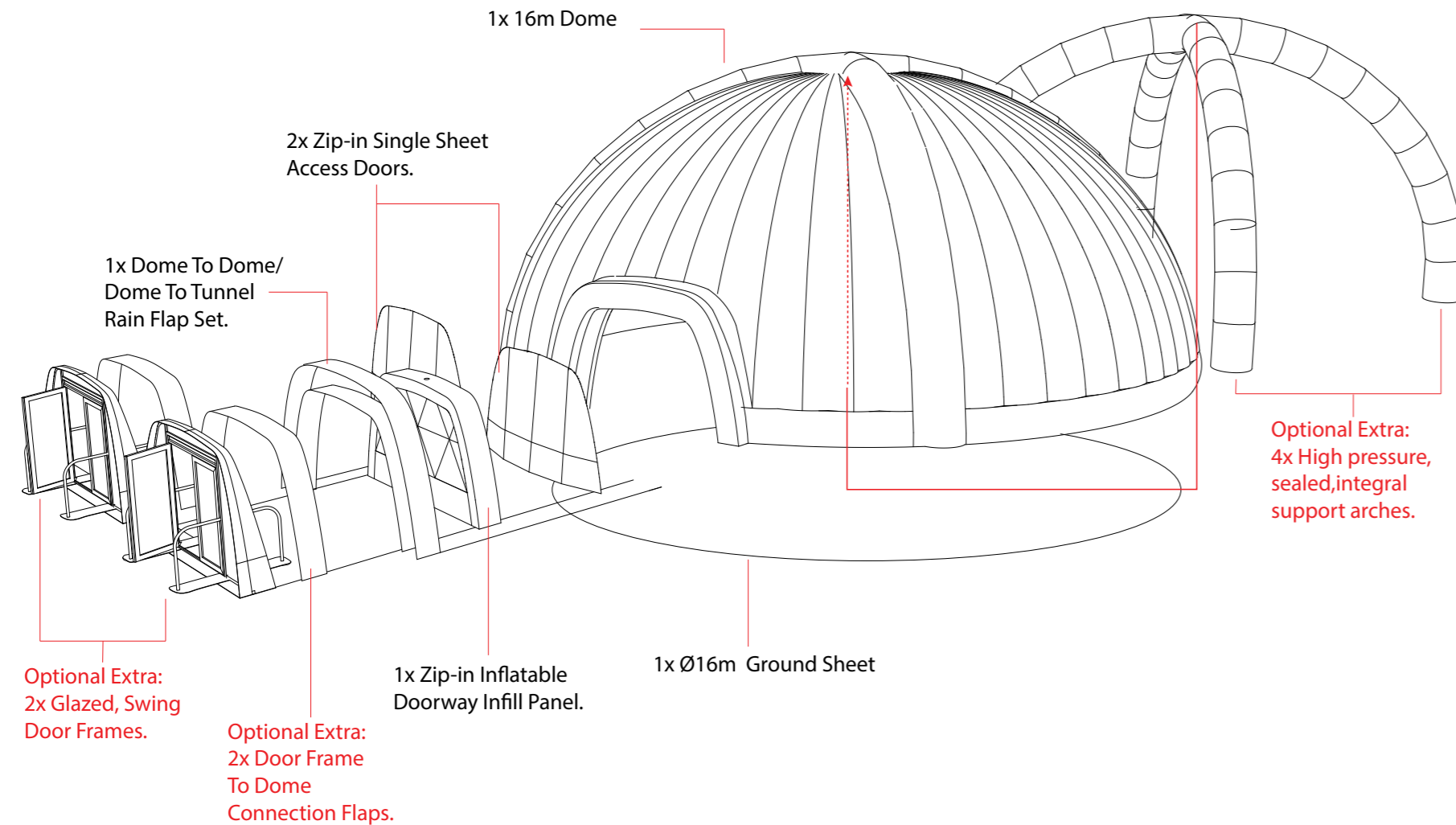

M3Air

Product specification

UK PACKAGE

- 1 x Structure, 1 x Packing Bag, 1 x Protection Ground Sheet, 2 x zip-in access doors, 1x zip-in inflatable door panel, 5 x 1.1KW fan.

STRUCTURE

- Packed Size: • 1800mm x 1600mm x 1400mm (est.)
- Packed Weight: • 640kg (est.)
- Inflated Size: • External - Ø16m x H7m
- Internal - Ø14.6m x H6.3m

- Internal Floor Area: • 162.5m²
- Plot Size Required: • 17m x 17m plus
- Entrance/Exit Size: • W4.08m, H2.46m
- Fabrics: • PVC, rip stop nylon FR treated
- Colours: • Combinations of white/black/silver/frosted
- Ground Fixings: • Refer to engineering guidance notes

Please Note: Information is correct at time of publication. The company accepts no responsibility for variations in dimensions or weights. The company reserves the right to alter any dimensions or weights at any time without prior notice.

POWER & FANS

- Fans: • 5 x 1.1KW fan
- Pumps: • high volume pumps, 1.8 KW
- Min Secure Power: • 18KVA
- Fan Weight: • 5.6 kg per fan
- Fan Dimensions: • 405mm x 405mm x 275mm

Please Note: It is the responsibility of the client or site management to ensure that the power used for fans is secure and tested. The above power consumption is for fans only and covers no extra electrical items. No other item should be connected to the fan power lines. The company accepts no responsibility for damages to equipment or damages to inflatable structures, injuries to persons, or loss of earnings due to electrical power faults.

INSTALLATION & DERIG

- Crew: • 5 persons (min)
- Set Up Time: • From 5 hours
- Inflation Time: • 20 mins for structure when fixed
- Derig Time: • From 4 hours

PRODUCT ENHANCEMENTS

- Noise Reduction Equipment • Branding - Temporary / Permanent / Banners/ Printed Covers • Ground Anchor Fixing • Glazed Doors
- Lighting • Trussing • Flooring • High Pressure supporting tube frame • Complete Interior Design and Production Service
- Custom Coloured Fabric • All Spares of Basic Package

Please Note: Refer to separate later page for more detail on product enhancement. Please note the above technical data can be effected by additional product enhancements. The company reserves the right to add or remove product enhancements from product range without prior notice.



Product capacity

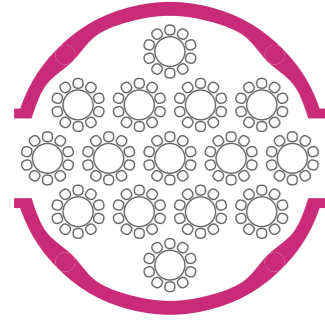

Restaurant Capacity:
15 Tables
150 Seats

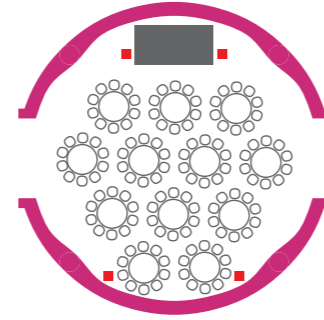

Caberet Capacity:
4x2m Stage
12 Tables
120 Seats

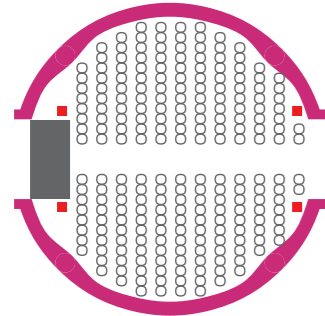

Conference Capacity:
4x2m Stage
32 Seats

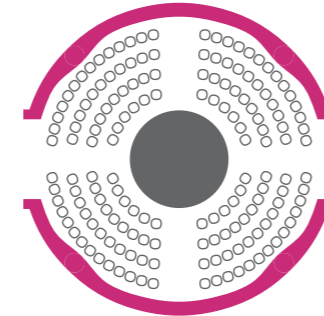

Arena Capacity:
4m Diameter Stage
160 Seats

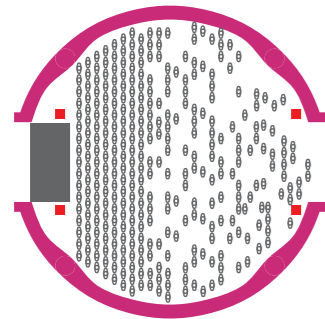

Concert Capacity:
4x2m Stage
325 People

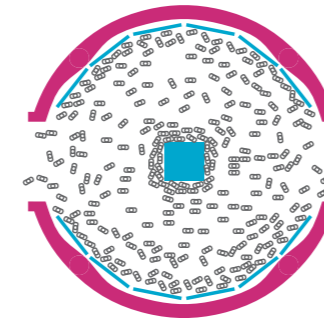

Exhibition Capacity:
13x Exhibition Stands
244 People

| Structure Footprint
  Table + 10 Seats
  Stage
  Speakers
  Exhibit
  People standing.

Product Enhancement

Branding

Branding can be applied permanently to any of the Inflatable structures as screen print or digital printing at the source of production.

Temporary branding can be added as vinyl or Dacron adhesive panels at any stage. Please note that not all artwork is suitable for printing on our structure range. It is advised sample artwork be supplied in an .eps format so we can advise the best solution. Full replaceable covers are available to the range. These can be branded and printed to ensure your structure matches your brand.

Bespoke colours and materials

All our structures are manufactured in ripstop nylon and reinforced PVC. As standard they are made in white and grey. Although a full colour range is available, this may alter lead times and costs.

Other materials are available and we are happy to discuss specific needs / projects and will advise on what we feel is the most appropriate solution. All fabrics are tested for performance of flammability for textiles used in the construction of marquees and similar textiles structures to standards: BS 7837:1996 / BS 5438:1989.

Lighting

As an optional extra we can provide internal LED lighting systems which will transform the look and feel of your inflatable structure. The ambient lighting effect can be either one colour change or mixed to produce your perfect environment.

Trussing

The M3 Air range of inflatable structures have been designed to be used as free standing products, trussing is not required to use them, however trussing can be added to enhance the environment. Full internal trussing systems are available to compliment your event structure. These can be used to hang PA equipment or other lighting options.

Doors & Closures

All of the M3 Air range comes complete with zip in/ out doors as standard. M3 Air also offers full aluminium double door systems. These provide fire safety openers and are fully lockable which provides increased security. The door systems are bespoke and made to be installed perfectly into our doorways.

Flooring

Flooring is available upon request and is offered to suit all event needs. We offer simple snap lock flooring. This offers light weight flooring and ideal for grass and concrete. It can be further enhanced by adding a finishing carpet.

We also offer aluminium / ply flooring which offers a professional and stable finish in any conditions. This type of flooring can take a number of finishers including carpet and wooden flooring.

Modularity

The entire M3 Air Range of Domes and Cubes can be joined together as the doorways are all standard. These can be jointed directly or by incorporating a space tunnel, these add an atmospheric walkway between the jointed structures and come in a range of lengths.

Transport

By its nature an inflatable structure packs down to considerably less than its inflated size. The largest of our range packs down to less than 2M³ which makes the structures ideal to store and use again. Each product will be supplied in its own storage bag and will be easily transported in an out of any venue.

Warranty

M3 Air offers a 12 month warranty on the manufacture process and materials if the user manual and install guides are followed. Due to the nature of weather and installation conditions, M3 Air reserves the right to carry out an onsite inspection and report which way the warranty will be met.